

## SMB Super Fast Recovery Diode 特快恢复二极管

### ■ Features 特点

High current capability 高电流能力  
Low forward voltage drop 低正向压降  
Super Fast Recovery time 特快恢复时间  
Surface mount device 表面贴装器件  
Case 封装:SMB

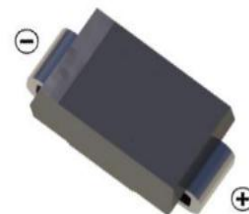

### ■ Maximum Rating 最大额定值

( $T_A=25^{\circ}\text{C}$  unless otherwise noted 如无特殊说明, 温度为  $25^{\circ}\text{C}$ )

Characteristic 特性参数	Symbol 符号	US 3AB	US 3BB	US 3DB	US 3EB	US 3GB	US 3JB	US 3KB	US 3MB	Unit 单位
Marking 印字		US 3A	US 3B	US 3D	US 3E	US 3G	US 3J	US 3K	US 3M	
Repetitive Peak Reverse Voltage 重复峰值反向电压	$V_{RRM}$	50	100	200	300	400	600	800	1000	V
DC Reverse Voltage 直流反向电压	$V_R$	50	100	200	300	400	600	800	1000	V
RMS Reverse Voltage 反向电压均方根值	$V_{R(RMS)}$	35	70	140	210	280	420	560	700	V
Forward Rectified Current 正向整流电流	$I_F$	3								A
Peak Surge Current 峰值浪涌电流	$I_{FSM}$	100								A
Thermal Resistance J-A 结到环境热阻	$R_{\theta JA}$	30								$^{\circ}\text{C}/\text{W}$
Junction/Storage Temperature 结温/储藏温度	$T_J, T_{stg}$	-65to+150 $^{\circ}\text{C}$								$^{\circ}\text{C}$

### ■ Electrical Characteristics 电特性

( $T_A=25^{\circ}\text{C}$  unless otherwise noted 如无特殊说明, 温度为  $25^{\circ}\text{C}$ )

Characteristic 特性参数	Symbol 符号	US3AB-US3DB	US3EB-US3GB	US3JB-US3MB	Unit 单位	Condition 条件
Forward Voltage 正向电压	$V_F$	1.0	1.3	1.85	V	$I_F=3\text{A}$
Reverse Current 反向电流	$I_R$	10( $T_A=25^{\circ}\text{C}$ ) 200( $T_A=100^{\circ}\text{C}$ )			$\mu\text{A}$	$V_R=V_{RRM}$
Reverse Recovery Time 反向恢复时间	$T_{rr}$	50		75	nS	$I_F=0.5\text{A}, I_R=1\text{A}$ $I_{rr}=0.25\text{A}$
Junction Capacitance 结电容	$C_J$	75			pF	$V_R=4\text{V}$ , $f=1\text{MHz}$

■ Typical Characteristic Curve 典型特性曲线

FIG.1-TYPICAL FORWARD CHARACTERISTICS

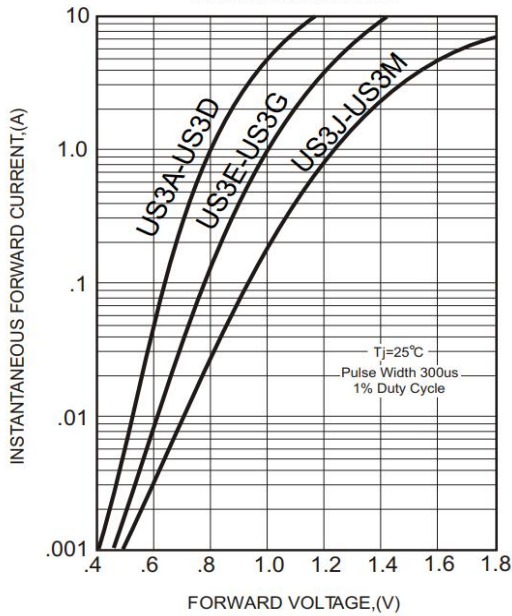

FIG.2-TYPICAL FORWARD CURRENT DERATING CURVE

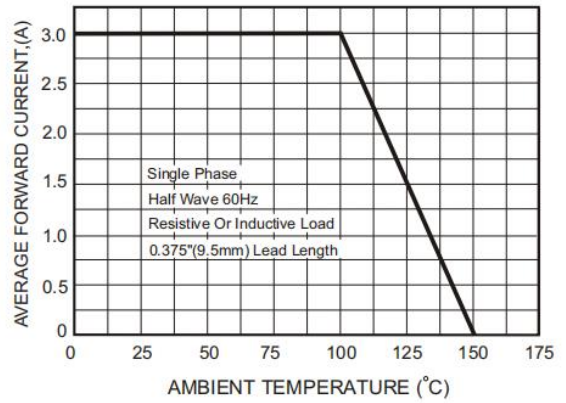

FIG.4-MAXIMUM NON-REPETITIVE FORWARD SURGE CURRENT

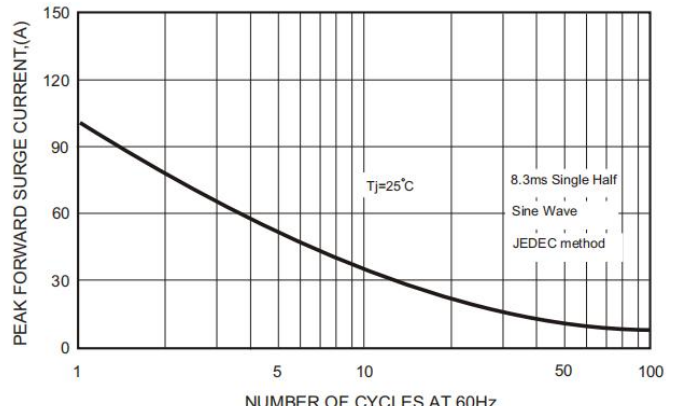
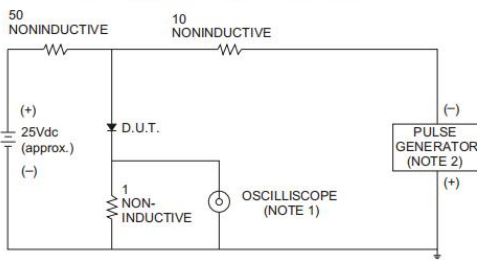

FIG.3- TEST CIRCUIT DIAGRAM AND REVERSE RECOVERY TIME CHARACTERISTICS



NOTES: 1. Rise Time= 7ns max., Input Impedance= 1 megohm, 22pF.  
2. Rise Time= 10ns max., Source Impedance= 50 ohms.

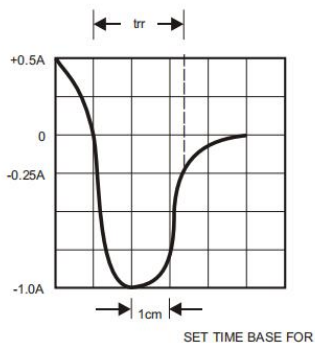
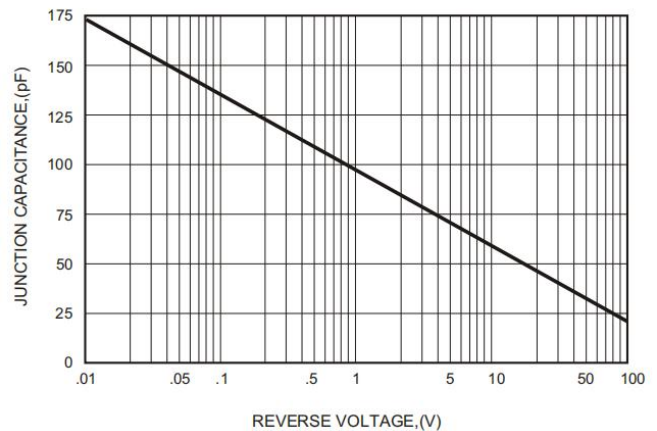
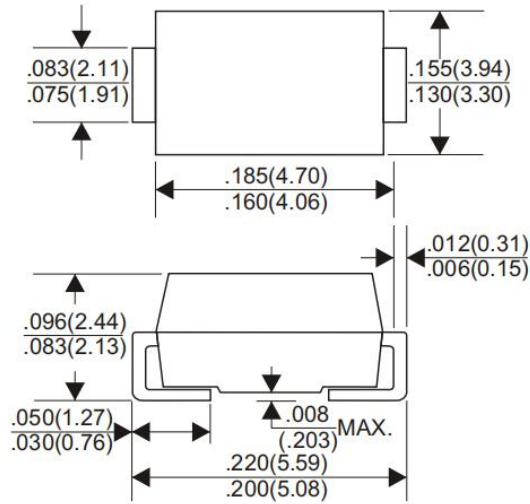

FIG.5-TYPICAL JUNCTION CAPACITANCE



■Dimension 外形封装尺寸

DO-214AA(SMB)



Dimensions in inches and (millimeters)