

**PDFN3.3X3.3-8 N Channel Enhancement 沟道增强型
MOS Field Effect Transistor 场效应管**

■ Features 特点

Low on-resistance 低导通电阻
 $R_{DS(ON)}=3.3m\Omega(\text{Type})@V_{GS}=10V$
 $R_{DS(ON)}=4.5m\Omega(\text{Type})@V_{GS}=4.5V$

■ Applications 应用

Load Switch 负载开关
 Uninterruptible power supply 不间断电源
 High current load applications 高电流负载应用
 Hard switched and high frequency circuits 硬开关和高频电路

■ Internal Schematic Diagram 内部结构

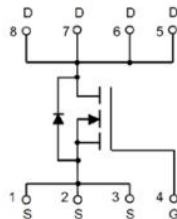
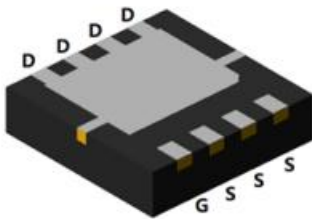

■ Absolute Maximum Ratings 最大额定值

Characteristic 特性参数	Symbol 符号	Rat 额定值	Unit 单位
Drain-Source Voltage 漏极-源极电压	BV_{DSS}	40	V
Gate- Source Voltage 栅极-源极电压	V_{GS}	± 20	V
Drain Current (continuous)漏极电流-连续	I_D (at $T_C = 25^\circ C$ at $T_C = 100^\circ C$)	50 31	A
Drain Current (pulsed)漏极电流-脉冲	I_{DM}	200	A
Total Device Dissipation 总耗散功率	P_{TOT} (at $T_A = 25^\circ C$ at $T_C = 25^\circ C$)	2.5 50	W
Avalanche Energy(Single Pulse)雪崩能量	EAS	400	mJ
Thermal Resistance Junction-Ambient 热阻	$R_{\theta JA}$	50	$^\circ C/W$
Junction/Storage Temperature 结温/储存温度	T_J, T_{stg}	-55~150	$^\circ C$

■ **Electrical Characteristics 电特性**

($T_A=25^{\circ}\text{C}$ unless otherwise noted 如无特殊说明, 温度为 25°C)

Characteristic 特性参数	Symbol 符号	Min 最小值	Typ 典型值	Max 最大值	Unit 单位
Drain-Source Breakdown Voltage 漏极-源极击穿电压($I_D=250\mu\text{A}, V_{GS}=0\text{V}$)	BV_{DSS}	40	—	—	V
Gate Threshold Voltage 栅极开启电压($I_D=250\mu\text{A}, V_{GS}=V_{DS}$)	$V_{GS(th)}$	1.0	1.5	2.5	V
Zero Gate Voltage Drain Current 零栅压漏极电流($V_{GS}=0\text{V}, V_{DS}=40\text{V}$)	I_{DSS}	—	—	1	μA
Gate Body Leakage 栅极漏电流($V_{GS}=\pm 20\text{V}, V_{DS}=0\text{V}$)	I_{GSS}	—	—	± 100	nA
Static Drain-Source On-State Resistance 静态漏源导通电阻($I_D=25\text{A}, V_{GS}=10\text{V}$) ($I_D=15\text{A}, V_{GS}=4.5\text{V}$)	$R_{DS(ON)}$	—	3.3 4.5	4.5 6	$\text{m}\Omega$
Diode Forward Voltage Drop 内附二极管正向压降($I_{SD}=25\text{A}, V_{GS}=0\text{V}$)	V_{SD}	—	0.8	1.2	V
Input Capacitance 输入电容 ($V_{GS}=0\text{V}, V_{DS}=20\text{V}, f=1\text{MHz}$)	C_{ISS}	—	4150	—	pF
Common Source Output Capacitance 共源输出电容($V_{GS}=0\text{V}, V_{DS}=20\text{V}, f=1\text{MHz}$)	C_{OSS}	—	430	—	pF
Reverse Transfer Capacitance 反馈电容 ($V_{GS}=0\text{V}, V_{DS}=20\text{V}, f=1\text{MHz}$)	C_{RSS}	—	420	—	pF
Total Gate Charge 栅极电荷密度 ($V_{DS}=20\text{V}, I_D=25\text{A}, V_{GS}=10\text{V}$)	Q_g	—	92	—	nC
Gate Source Charge 栅源电荷密度 ($V_{DS}=20\text{V}, I_D=25\text{A}, V_{GS}=10\text{V}$)	Q_{gs}	—	9	—	nC
Gate Drain Charge 栅漏电荷密度 ($V_{DS}=20\text{V}, I_D=25\text{A}, V_{GS}=10\text{V}$)	Q_{gd}	—	27	—	nC
Turn-ON Delay Time 开启延迟时间 ($V_{DS}=20\text{V}, I_D=25\text{A}, R_{GEN}=2.2\Omega, V_{GS}=10\text{V}$)	$t_{d(on)}$	—	14	—	ns
Turn-ON Rise Time 开启上升时间 ($V_{DS}=20\text{V}, I_D=25\text{A}, R_{GEN}=2.2\Omega, V_{GS}=10\text{V}$)	t_r	—	119	—	ns
Turn-OFF Delay Time 关断延迟时间 ($V_{DS}=20\text{V}, I_D=25\text{A}, R_{GEN}=2.2\Omega, V_{GS}=10\text{V}$)	$t_{d(off)}$	—	61	—	ns
Turn-OFF Fall Time 关断下降时间 ($V_{DS}=20\text{V}, I_D=25\text{A}, R_{GEN}=2.2\Omega, V_{GS}=10\text{V}$)	t_f	—	11	—	ns

■ Typical Characteristic Curve 典型特性曲线

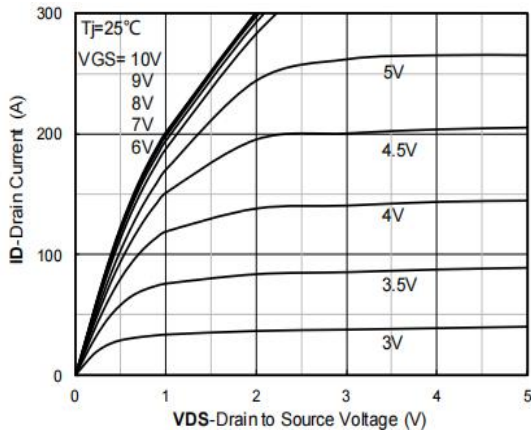

Figure 1: Output Characteristics

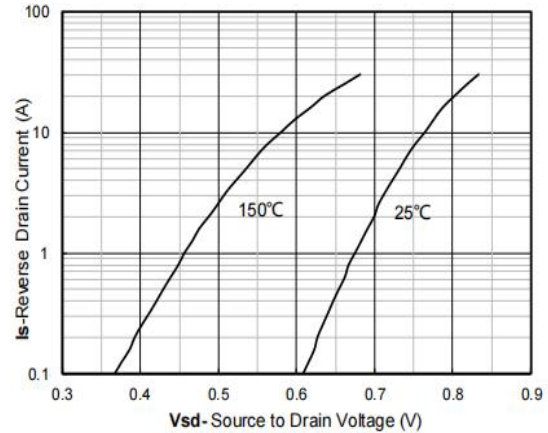

Figure 2: Diode Forward Characteristics

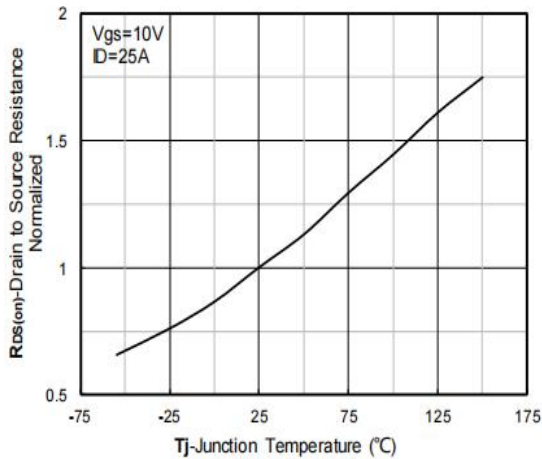

Figure 3: On-Resistance vs. T_j

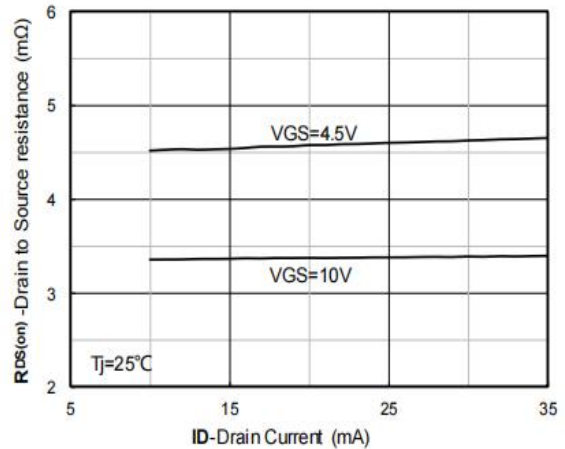

Figure 4: On-Resistance vs. Drain Current

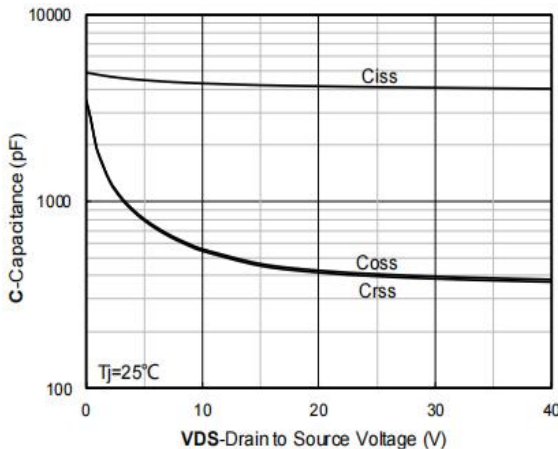

Figure 5: Capacitance Characteristics

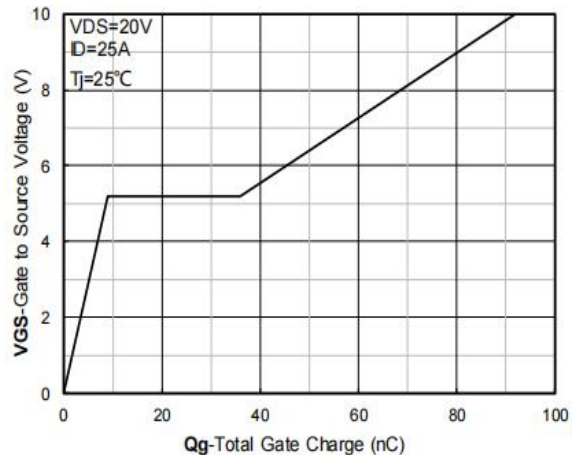

Figure 6: Gate-Charge Characteristics

■ Typical Characteristic Curve 典型特性曲线

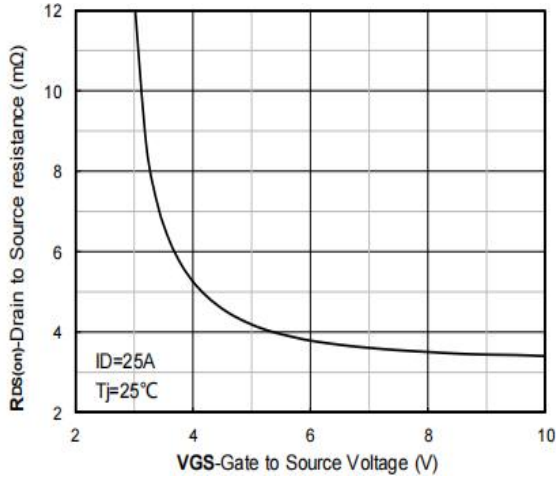

Figure 7: Drain Current vs. V_{GS}

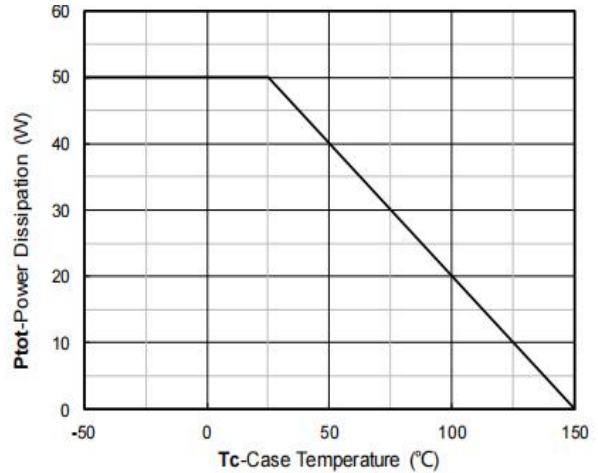

Figure 8: Power Rating Curve

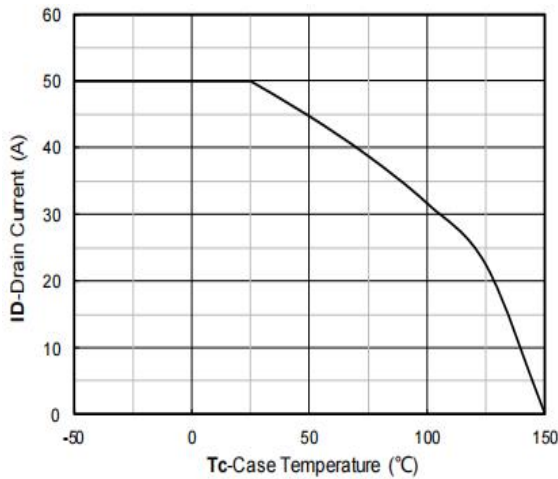

Figure 9: Drain Current Characteristics

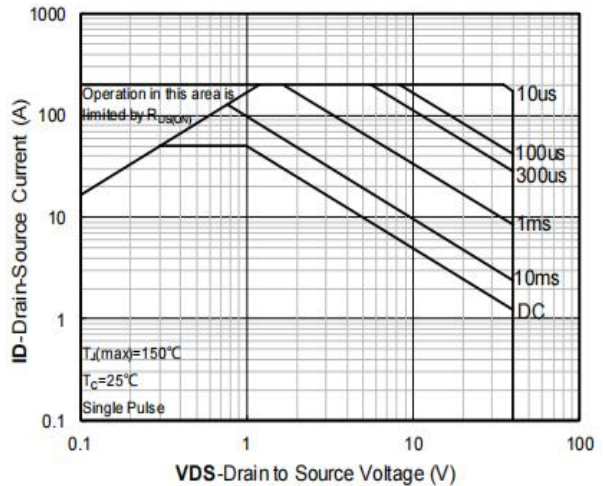

Figure 10: Safe Operating Area

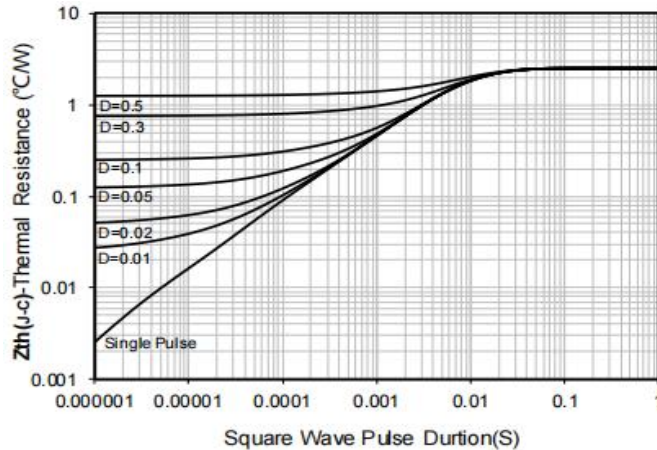
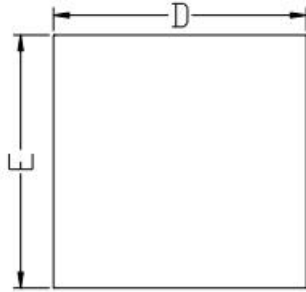
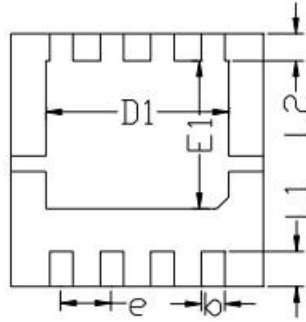

Figure 11: Transient Thermal Response Curve

■ Dimension 外形封装尺寸



Top View
正面视图



Bottom View
背面视图

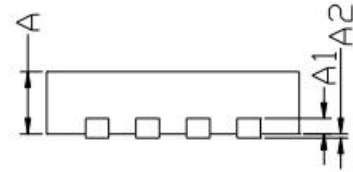

Side View
侧面视图

SYMBOL	MILLIMETER		
	MIN	NOM	MAX
D	3.15	3.25	3.35
E	3.15	3.25	3.35
A	0.70	0.80	0.90
A1	0.20 BSC		
A2			0.10
D1	2.20	2.35	2.50
E1	1.80	1.90	2.00
L1	0.35	0.45	0.55
L2	0.35 BSC		
b	0.20	0.30	0.40
e	0.65 BSC		